

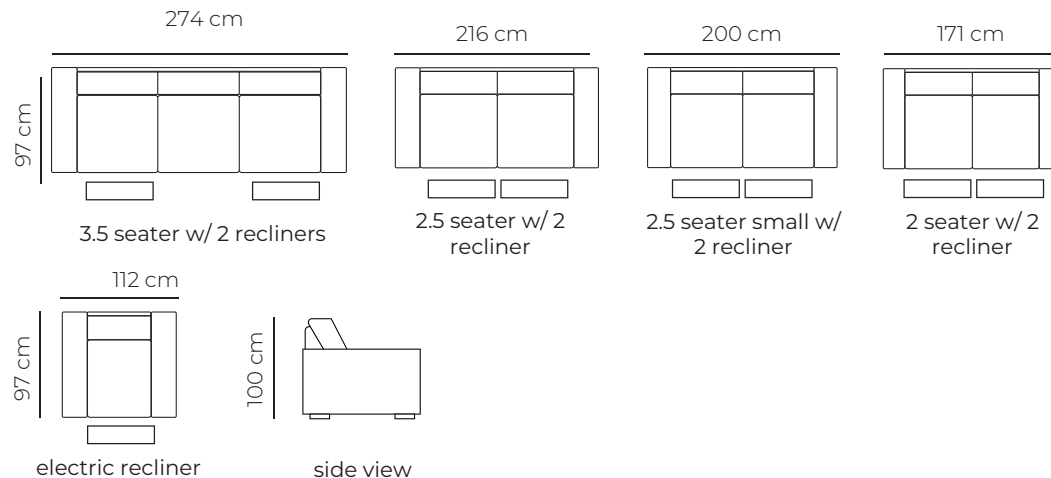

### Flynn Dimensions



### Flynn

3.5s Leather sofa in Nevada Tan Leather

### Construction

- Kiln-dried plantation timber frame
- No sag spring suspension
- High density foam with fibre wrap seating
- Channelled fibre back cushions
- Timber feet

### Features & Benefits

- Available in a large range of leather and fabric options
- Non-reclining options available
- Battery Option available
- 10 Year frame warranty
- No Sag Spring Suspension
- Build your size couch

### Notes

### Flynn Modular Components

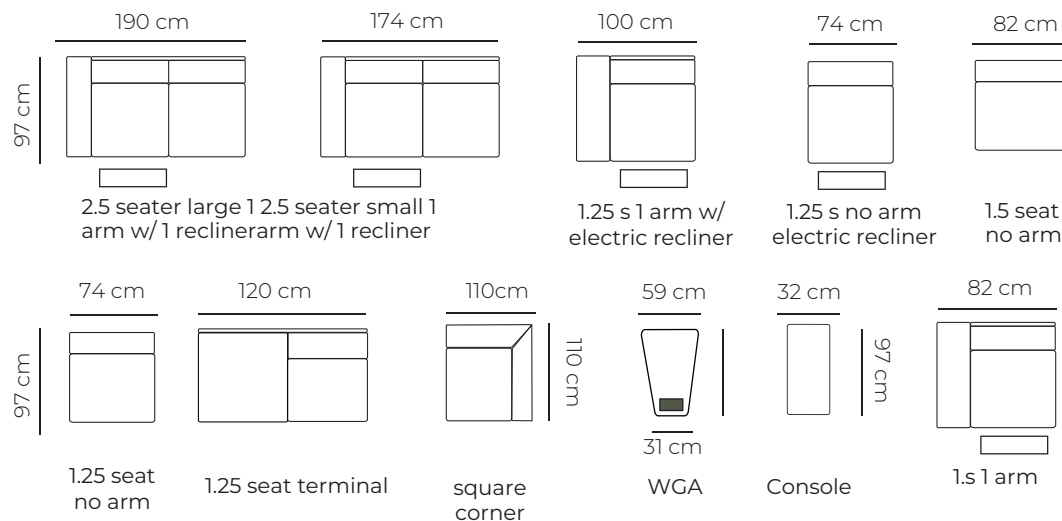

\*measurements are approximate and are subject to commercial tolerance



Power reclining function



Large choice of leather + fabrics



No sag spring base



10 Year Frame Warranty



Battery Option



Scan for more information & options on our Flynn Range or visit: [berkowitz.com.au](http://berkowitz.com.au)

**Berkowitz**  
A FURNITURE FAMILY



### Flynn Modular Configurations

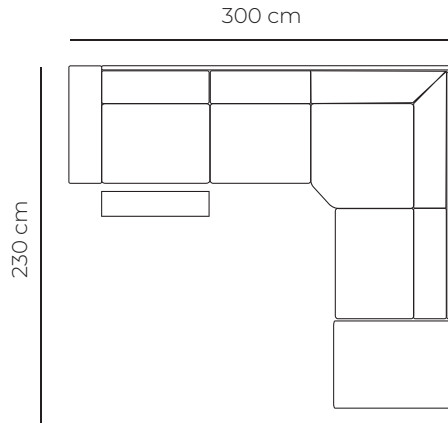

2.5 seat large square corner modular & terminal RHF with 1 recliner

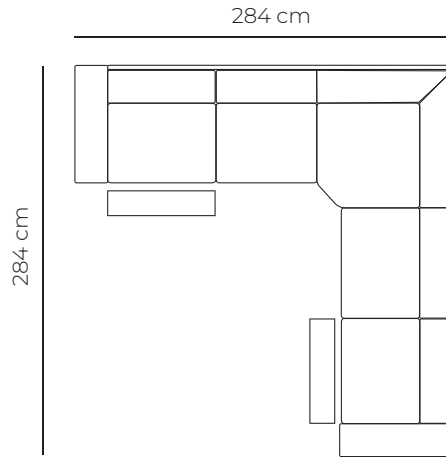

2.5 seat small square corner modular with 2 recliners

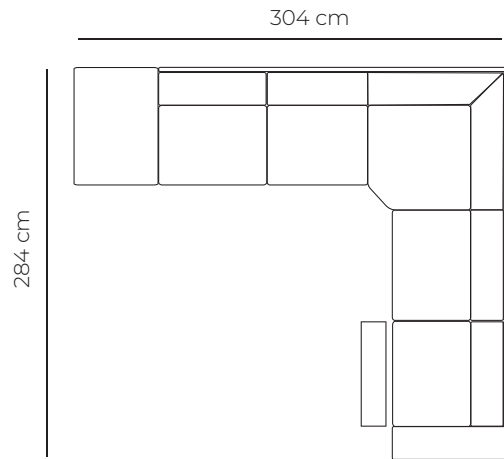
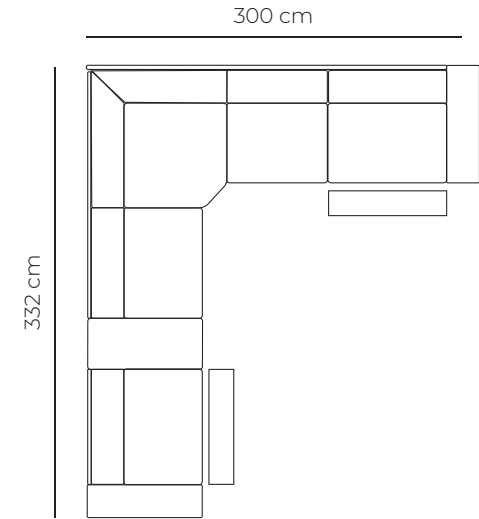

2.5 seat small square corner modular with 1.25 seat no arm & terminal LHF with 1 recliner

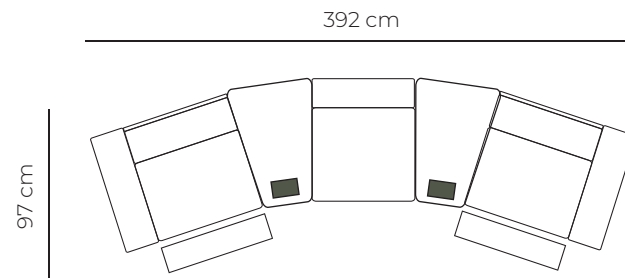

3.5 seat home theatre with 2 recliners & 2 consoles